



# Specifications

## Angle Drill

-  Double Insulation
-  Torque Limiter  
(Model DA4031 only)
-  Reversing

Drilling capacities	Model DA4030	Model DA4031
Wood		
Auger-bit	38 mm (1-1/2")	38 mm (1-1/2")
Self-feed bit	65 mm (2 -9/16")	118 mm (4-5/8")
Hole saw	65 mm (2 -9/16")	152 mm (6")
Steel		
Twist bit	13 mm (1/2")	13 mm (1/2")
Continuous rating		
Input	1,050 W	1,050 W
No load speed	1,200 min <sup>-1</sup> (rpm)	Hi : 1,200 min <sup>-1</sup> (rpm) Lo : 300 min <sup>-1</sup> (rpm)
Overall length	418 mm (16-1/2")	462 mm (18-1/4")
Net weight	4.8 kg (10.6 lbs)	5.6 kg (9.5 lbs)
Power supply cord	2.5 m (8.2 ft.)	2.5 m (8.2 ft.)

Specifications may differ from country to country.

## Dimension

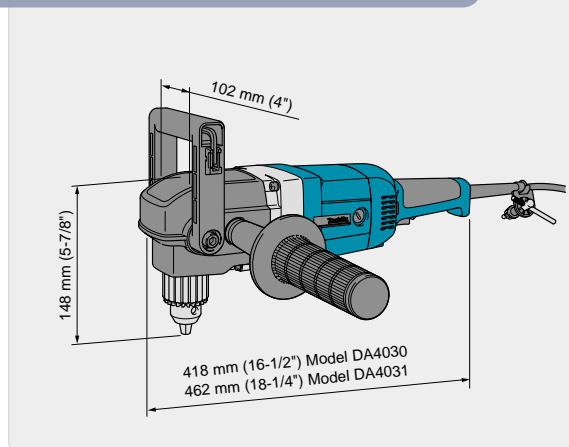

A world's leading manufacturer of power tools

 Double Insulation

 Reversing

 Torque Limiter

(Model DA4031 only)

# 13 mm (1/2") Angle Drill

## Model DA4030 / DA4031

# Standard equipment

## Angle Drill

	Part No.
Drill chuck	193381-7
Chuck key	763432-9
Drill chuck (For USA, Canada & Mexico)	193319-5
Chuck key (For USA, Canada & Mexico)	763434-5
Grip 27	273654-8
Hex wrench 6	783204-6
Plastic carrying case	824647-4

# Optional accessories

## Angle Drill

	Part No.
Drill chuck	193381-7
Chuck key	763432-9
Drill chuck (For USA, Canada & Mexico)	193319-5
Chuck key (For USA, Canada & Mexico)	763434-5
Grip 27	273654-8
Hex wrench 6	783204-6
Plastic carrying case	824647-4

*Power and torque for extra efficient drilling between studs and joists*



Photo: DA4031

**NEW**

Makita Corporation

3-11-8, Sumiyoshi-cho, Anjo, Aichi 446-8502, Japan

PRINTED IN JAPAN Z23011-2 2001-6



A world's leading manufacturer of power tools

Unrivaled drilling capacity and ergonomic design ensure the best performance in 2 X 4 constructions, plumbing and electric installation works.



Photo: DA4030

**Storage for Hex Wrench**  
Hex wrench for installing the front handle can be stored to prevent it from being lost.

**Torque Limiter in Low Speed**  
Reduces dangerous return torque when the bit is caught by the material. (for DA4031 only)

**Soft Grip**  
Fits your hand perfectly for comfortable operation.

**Durable Cord Guard**  
The flexible and elastic rubber cord guard makes power supply cord more durable against disconnection than ever.

**3. Rear Handle Swivels 90 Degrees Left or Right for Easy Drillings.**

**1. Easy-to-Operate, Large Speed Change Lever**

**2. Easy-to-Operate Switches**

**1. Push-button type reversing switch allows you to reverse the rotation while holding the handle.**

**2. Large trigger on main switch for easy operation.**

**For quick high/low speed change (for DA4031 only)**

**Tool-free angle adjustment of rear handle can be done for the 90 degrees left or right to your application.**

Photo: DA4031

### Performance Data

Note: It may differ under some conditions.

#### ■ Drilled 6 SPF boards in a pile with 1" auger bit

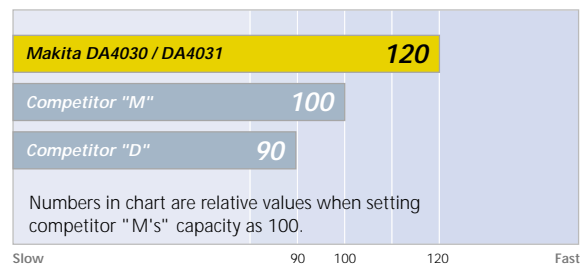

#### ■ Drilled an SPF board with 4-5/8" selffeed bit

