

Standard equipment

Rotary Hammer

Model HP2070, HP2070F	Part No.
Grip 36 complete	152521-9
Depth Gauge (Stopper pole)	324219-0
Drill chuck	192877-8
Chuck key	763432-9
Plastic carrying case	824650-5

Model HP2071, HP2071F	Part No.
Grip 36 complete	152521-9
Depth Gauge (Stopper pole)	324219-0
Keyless drill chuck	192664-5
Plastic carrying case	824650-5

Items of standard equipment may differ from country to country.

Optional accessories

Rotary Hammer

Tungsten carbide-tipped bit



Bit diameter (mm)	Overall length (mm)	Part No.
5.0	70	791027-8
6.5	80	791092-7
7.5	90	791028-6
8.0	120	711057-3
8.5	100	791008-2
8.5	180	711026-4
9.5	120	711058-1
10.5	120	711059-9
11.0	120	791009-0
12.5	120	711060-4
14.0	150	791029-4
14.0	180	711027-2
14.0	300	711028-0
16.0	220	791036-7
19.0	220	791037-5

Hole saw With high quality carbide tips brazed on to the cutting edge, high speed drilling of plates up to 4 mm is possible and no coolant is required. Carbide tips are random-spaced to reduce chattering. (Keep rotation mode)



Bit diameter (mm)	Shank dia. (mm)	Part No.
16	6	B-00898
18		B-00907
20		B-00913
21		B-00929
22		B-00935
25		B-00941
27	10	B-00957
28		B-00963
30		B-00979
32		B-00985
35		B-00991
38		B-01002
40		B-01018
45		B-01024
48		B-01030
50		B-01046
55		B-01052
60		13
65	B-01074	
70	B-01080	
75	B-01096	
80	B-01105	
85	B-01111	
90	B-01127	

Metal borer With high quality carbide tips brazed on to the cutting edge, high speed drilling of plates up to 12 mm is possible and no coolant is required. Carbide tips are random-spaced to reduce chattering. (Keep rotation mode)



Bit diameter (mm)	Part No.
14	B-02266
14.5	B-02272
15	B-02288
16	B-02294
17	B-02303
18	B-02319
19	B-02325
20	B-02331
21	B-02347
22	B-02353
23	B-02369
24	B-02375
25	B-02381
26	B-02397
27	B-02406
28	B-02412
29	B-02428
30	B-02434
31	B-02440
32	B-02456
33	B-02462
34	B-02478
35	B-02484

Blow-out bulb
(For blowing chips and dust from drilled holes)

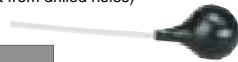

Part No.
765009-6

Type 43 drill stand



Part No.
JPA122190

Center drill For hole saw



Application	For hole saw bit diameter (mm)	Part No.
Steel, stainless steel, copper, aluminum, etc.	16 — 55	B-01177
	60 — 90	B-01183
FRP, resin, etc.	16 — 55	B-01199
	60 — 90	B-01208

Shank assembly (For metal borer)



Type	Shank dia.	Part No.
Center drill type	10 mm	B-02490
Center pin type	13 mm	B-02509



A world's leading manufacturer of power tools

Double Insulation	Built-in Job Light (HP2070F / HP2071F)	Soft Start
Variable Speed	Electronic Speed Control	Mechanical 2-Speed
Reversing	Torque Limiter	Carrying Case

20mm (3/4") 2-Speed Hammer Drill

Model HP2070 / HP2070F HP2071 / HP2071F



NEW



A world's leading manufacturer of power tools

Efficiency and power maximized by in-line positive grip design and powerful 1,010W motor !

Performance Data

Note: It may differ under some conditions.

Drilling speed

Workpiece : Mortar

When Hammer drilling with : $\phi 12.5$ mm (1/2") bit.

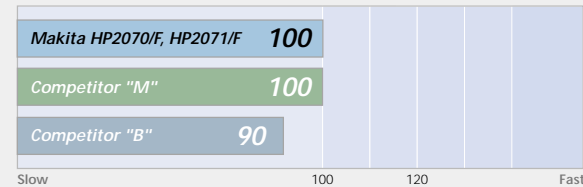

When Hammer drilling with : $\phi 19.0$ mm (3/4") bit.

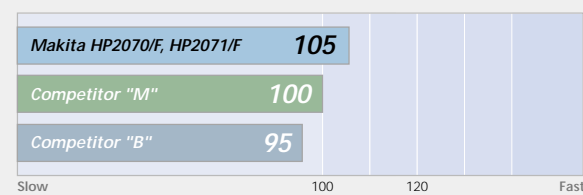

Workpiece : Douglas fir (Wood)

When drilling with : $\phi 36$ mm (1-7/16") Auger bit.

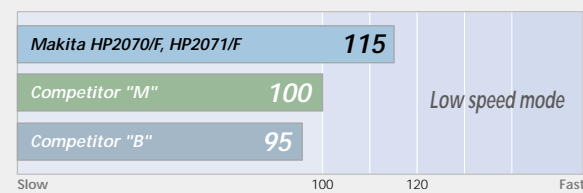

Numbers in chart are relative values when setting competitor "M's" capacity as 100.

2 Speed Hammer Drill 20 mm (3/4")



Photo: HP2070F

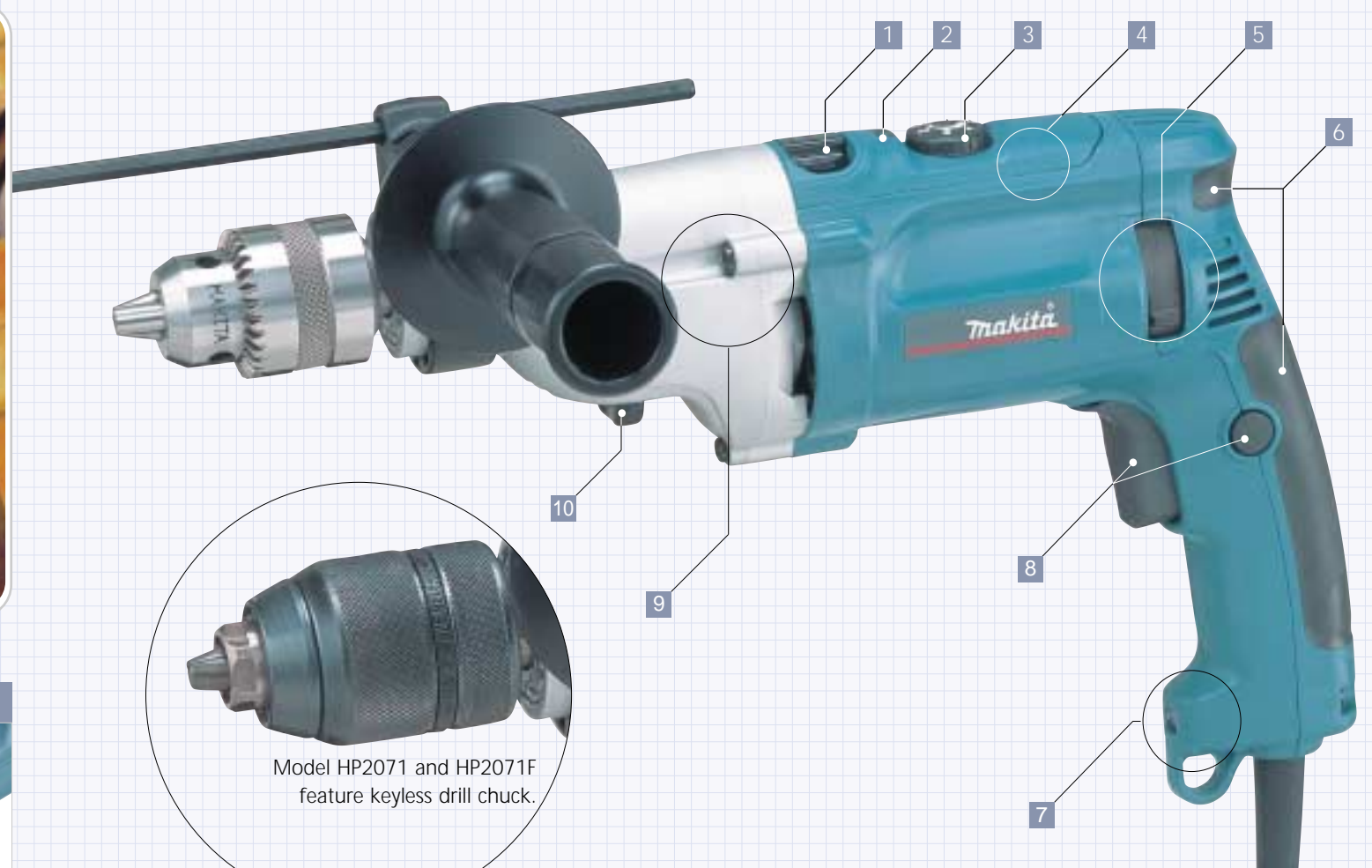
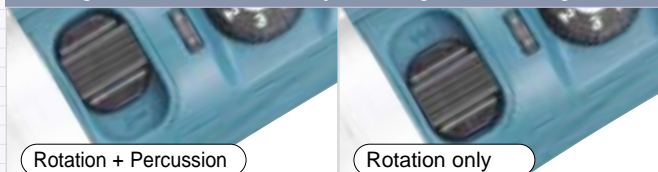
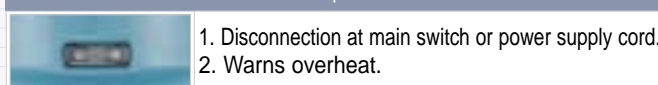

PHOTO: Model HP2070F

1. Large lever has made it easy to change the working modes.



2. Convenient indicator lamp.



Dimension

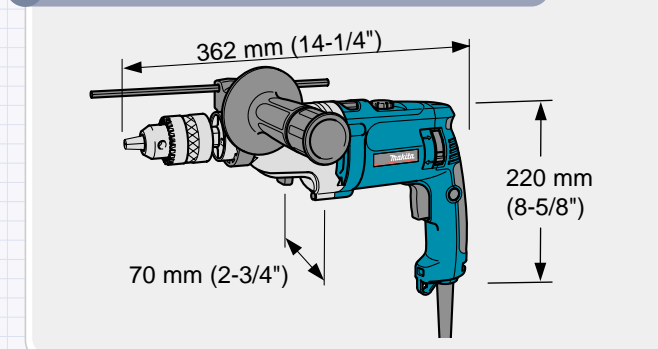

Model HP2071 and HP2071F feature keyless drill chuck.

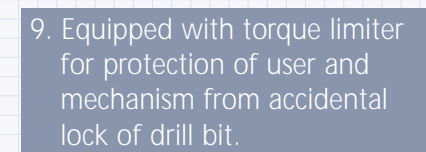
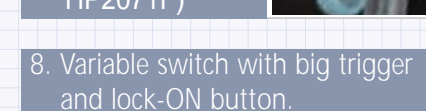
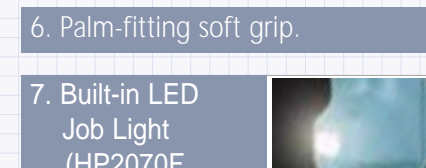
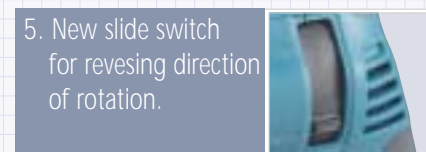
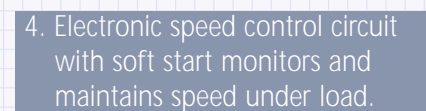
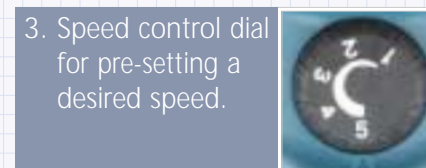

	Built-in Job Light	Keyless drill chuck
HP2070	No	No
HP2070F	Yes	No
HP2071	No	Yes
HP2071F	Yes	Yes

Specifications

Rotary Hammer

Max. capacities

Concrete (Hammer bit)	20 mm (3/4")
Steel	High : 8 mm (5/16") Low : 18 mm (5/8")
Wood	High : 25 mm (1") Low : 40 mm (1-9/16")
Continuous rating	Input 1,010W
No load speed	High : 0 - 2,900 min ⁻¹ (rpm) Low : 0 - 1,200 min ⁻¹ (rpm)
Blows per minute	High : 0 - 58,000 min ⁻¹ (bpm) Low : 0 - 24,000 min ⁻¹ (bpm)
Overall length	360 mm (14-1/8")
Net weight	2.4 kg (5.3 lbs)
Power supply cord	2.5 m (8.2 ft.)

Specifications may differ from country to country.