

Dust-free work with MAKITA Dust Collection System



WITHOUT Dust Cup and Vacuum Cleaner



- Overhead application: Dust and debris falling on operator's face are disturbing.
- Vertical application: Debris may damage floor surface.
- Downward application: Troublesome cleaning is required to wipe dust and debris away from drilled hole surrounding.

WITH Dust Cup and Vacuum Cleaner



- Dust cup collects falling dust and debris to protect operator's face.
- With Vacuum cleaner, this dust cup can efficiently extract dust and debris in a wide range of drilling operations; from overhead to vertical downward applications.
- Higher visibility of the bit tip obtained by transparent cup mouth

Comparison of Efficiency

- The test results depend to a great extent on the hardness of the material, etc.
 - Numbers in the chart below are relative values when the capacity of Makita predecessor model is indexed at 100.
- Test conditions: Drilled holes to a depth of 40mm (1-9/16") using ø1.5mm² x 50m cord reel.
Test material: Concrete with compressive strength of 40N/mm²

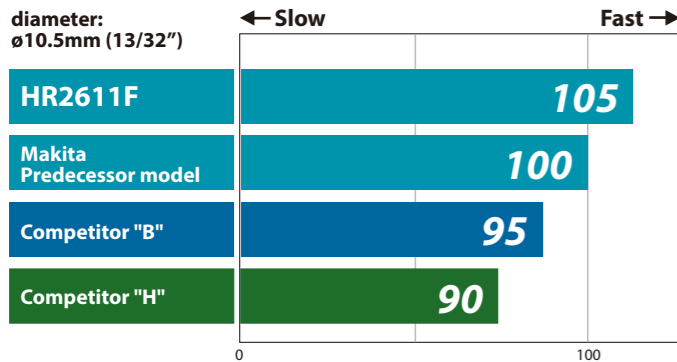

See the Result of AVT

Comparison of Vibration level* and Time to reach ELV (Exposure Limit of Vibration)**

- *It is known as the tri-axial value and value at Directive of A(8).
- **It means the maximum amount of vibration that an operator may be exposed to on any single day.

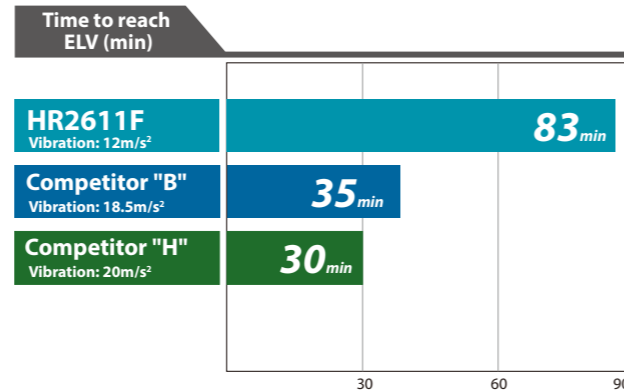

Combination Hammers (3 mode), Rotary Hammers (2 mode) Adapted for SDS-PLUS bits

	26mm (1")		26mm (1")		26mm (1")		23mm (7/8")	
	HR2611F	HR2610	HR2611FT	HR2610T	HR2601	HR2600	HR2310T	HR2300
AVT (Anti Vibration Tech)	●	●	●	●	●	●	●	●
LED job light	●	●	●	●	●	●	●	●
Quick change drill chuck	●	●	●	●	●	●	●	●
Operation Mode	3 Modes	3 Modes	3 Modes	3 Modes	2 Modes	2 Modes	3 Modes	2 Modes
Continuous rating input	800W		800W		800W		720W	
Capacity	Concrete : 26mm (1") Steel : 13mm (1/2") Wood : 32mm (1-1/4")		Concrete : 26mm (1") Steel : 13mm (1/2") Wood : 32mm (1-1/4")		Concrete : 26mm (1") Steel : 13mm (1/2") Wood : 32mm (1-1/4")		Concrete : 23mm (7/8") Steel : 13mm (1/2") Wood : 32mm (1-1/4")	
Impacts per minute (ipm)	0 - 4,600		0 - 4,600		0 - 4,600		0 - 4,600	
No load speed (rpm)	0 - 1,200		0 - 1,200		0 - 1,200		0 - 1,200	
Dimensions (L x W x H)	361x77x209mm (14-1/4"x3"x8-1/4")		385x77x209mm (15-1/8"x3"x8-1/4")		361x77x209mm (14-1/4"x3"x8-1/4")		356x77x209mm (15"x3"x8-1/4") (14"x3"x8-1/4")	
Net weight*	2.9kg (6.4lbs) 2.8kg (6.1lbs)		3.0kg (6.6lbs) 2.9kg (6.4lbs)		2.9kg (6.3lbs) 2.8kg (6.2lbs)		2.9kg (6.3lbs) 2.7kg (5.9lbs)	
Power supply cord	4.0m (13.1ft)		4.0m (13.1ft)		4.0m (13.1ft)		4.0m (13.1ft)	

Standard Equipment : Side Grip, Depth Gauge, Quick change drill chuck (HR2611FT, HR2610T, HR2310T)
(Tool does not come with bit.)

*Weight according to EPTA-Procedure 01/2003
Items of standard equipment and specifications may vary by country or area.



Combination Hammer
HR2611F series

Rotary Hammer
HR2601 series

Satisfy Professional's Needs



Adapted for
SDS-PLUS bits

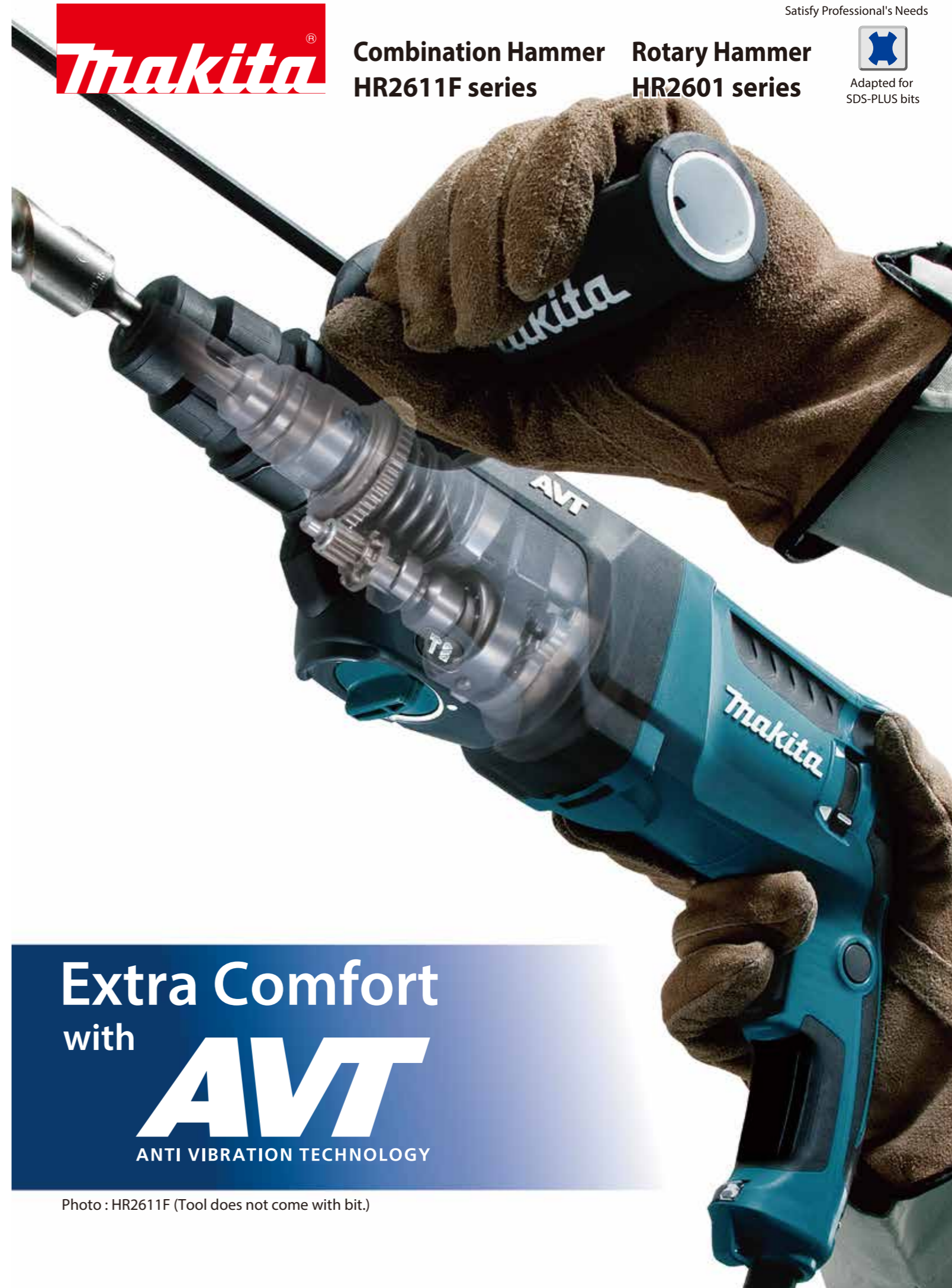

Extra Comfort
with
AVT
ANTI VIBRATION TECHNOLOGY

Photo : HR2611F (Tool does not come with bit.)

Makita Corporation

3-11-8 Sumiyoshi-cho, Anjo, Aichi, 446-8502 Japan

PRINTED IN JAPAN BB-AF

Extremely low vibration achieved by ...

AVT

ANTI VIBRATION TECHNOLOGY

(HR2611F, HR2611FT, HR2601)

Counterweight mechanism

dampens the vibration produced by impact mechanism by moving a counterweight in the opposite direction to the movement of the piston.

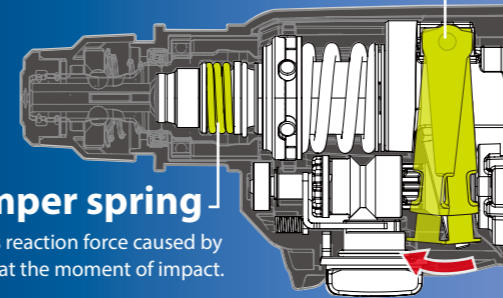

Damper spring

absorbs reaction force caused by drill bit at the moment of impact.

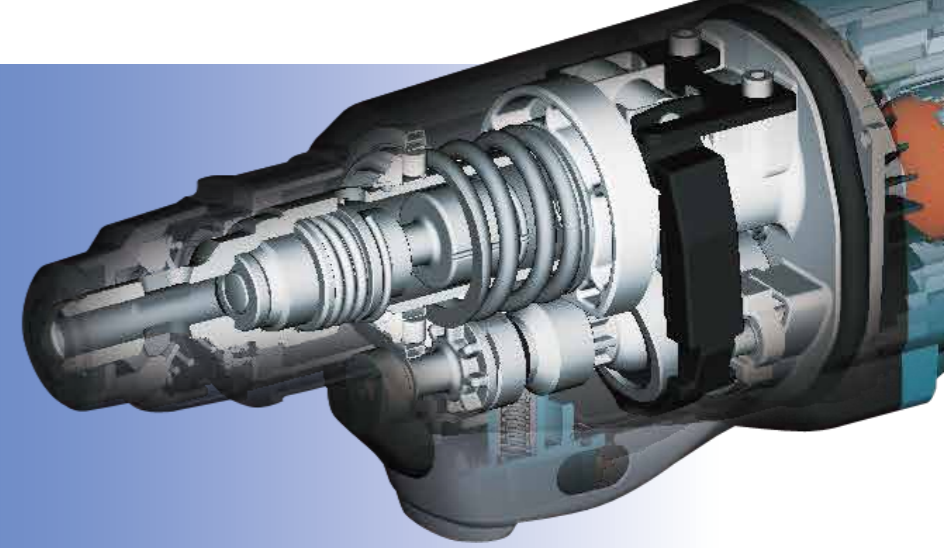

Dust cup (Option)

is suited for interior or overhead drilling where dust exposure must be avoided.



Easy depth adjustment

Depth gauge can be adjusted with a single motion.



Rotation reversing system using brush holder unit

Features the following advantages:

- Protects Carbon Brush from foreign dusts and debris.
- Life of Carbon Brush is 2.7 times long as the existing models.
- Same speed and torque even in reverse rotation
- Saves time and labor for repair thanks to simplified wiring.



Easy-to-grip handle

ergonomically designed to give maximum power thrust

Rubberized soft grip

provides more comfort and control.



Quick change drill chuck

from SDS-PLUS to 3 jaw chuck literally in a second.

(HR2611FT, HR2610T, HR2310T)



Minimum bit wobbling

with longer bit guide

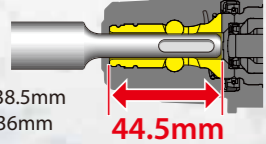

Competitor B : 38.5mm
Competitor H : 36mm

One-touch sliding chuck

for easy bit changes

40 Different bit-angle settings

The bit-angle is adjustable without chisel adapter.

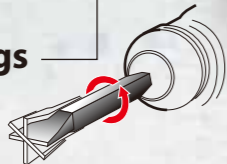

23mm (7/8")/ 26mm (1")

Combination Hammer 3 mode
Rotary Hammer 2 mode



Adapted for SDS-PLUS bits

Torque limiter

When drill bit hits against reinforcements, Torque limiter operates to stop.

Operation mode change lever

positioned on the bottom of gear housing for reduced possibility of breakage



Rotation

Hammering

LED job light

with afterglow function



(HR2611F, HR2611FT)



Rotation with hammering



Hammering (HR2611F, HR2610, HR2611FT, HR2610T, HR2310T)



Rotation (Drill Chuck is option)

Photo : HR2611F (Tool does not come with bit.)